

**SYV**<sup>®</sup>

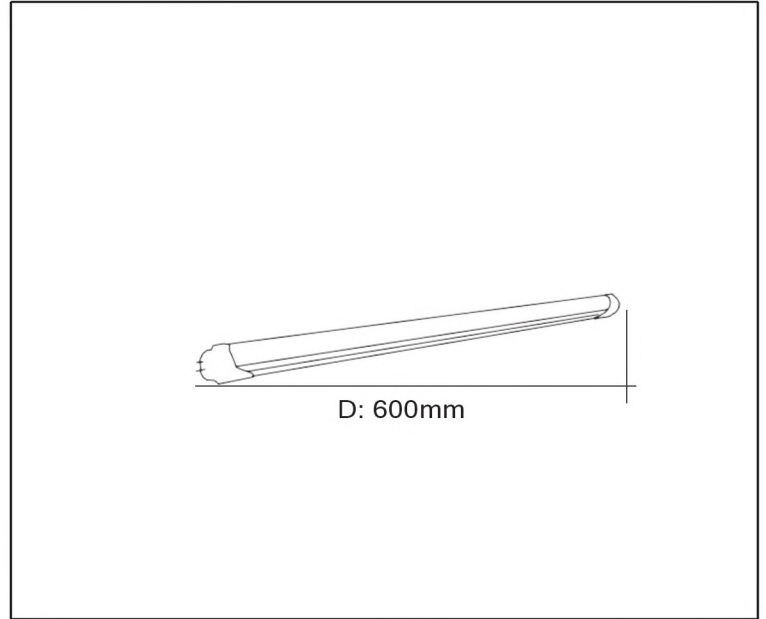

LED LAMP

## TECHNICAL DATA SHEET - GLAX 8 DL - 12698 - LED TUBELIGHT



12698  
 EPISTAR LED  
 Rated Luminaire luminous flux: 1050lm  
 Rated input power: 8W  
 Luminaire efficiency: 131lm/w  
 Input voltage: AV175-240V

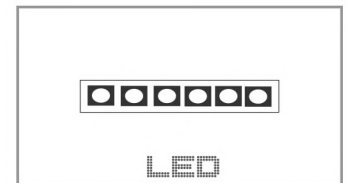

### Product Description

With patented driver design, LED tube light is able to work with 90% of the major ballasts in the market regardless of whether it is inductive or electronic, the unique designed lens with oval shape makes it look same as fluorescent tube when light up. Universal compatible design allows you to replace the fluorescent tube directly without rewiring.

### Technical Data

Product Data	LED Tubelight
Wattage	8W
Color Temperature	6500K
Rated Luminaire Luminous Flux	1050lm
IP Rating	20
Beam Angle	240°
Frequency Range	50-60Hz
CRI	Ra>80
Power Factor	>0.9
Material	Acrylic body + Aluminium Heat Sink + Frosted Cover
Finish	White
Life Span	20,000Hrs
Warranty	2 Years
Applications	Residential, Commercial, Retail, etc.