

Suspension Chain Installation Manual

Step 1

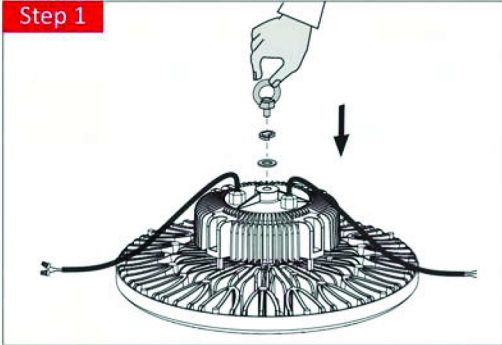

Step 2

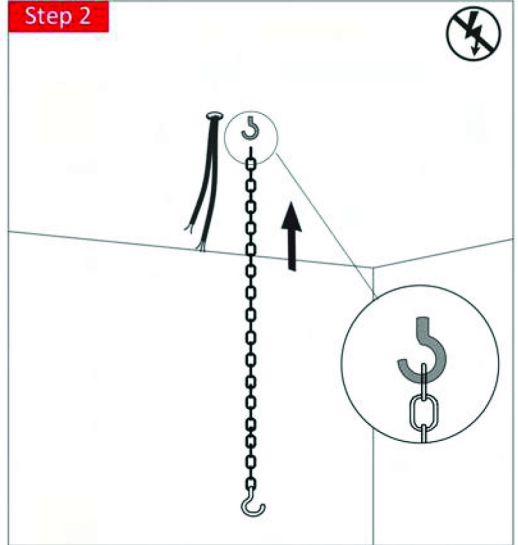

Step 3

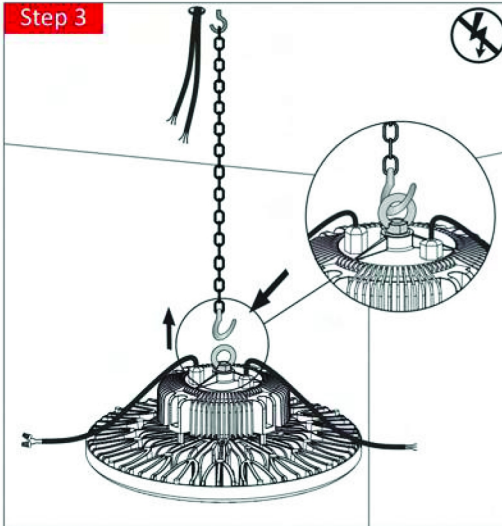

Step 4

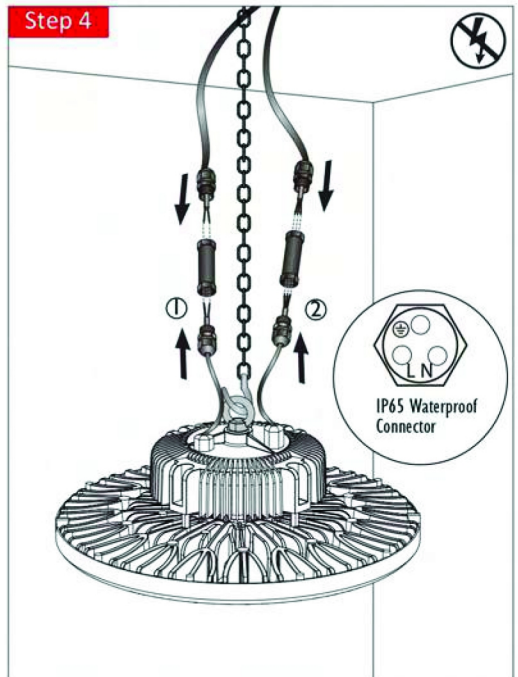

Note:

	CE version:	ETL version:
① 1-10V dimming cable	+ Brown - Blue	+ Purple - Grey
② 100-277V AC cable	N Blue L Brown ⊕ Green	N White L Black ⊕ Green

Warning:

- ① Incorrect installation may result in power burned or a risk of a fire.
- ② If don't need dimming, protect the 1-10V output with the protection caps provided with the product.

Wall Mounting Installation Manual

Step 1

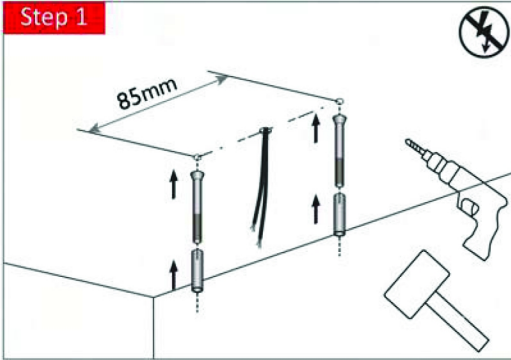

Step 2

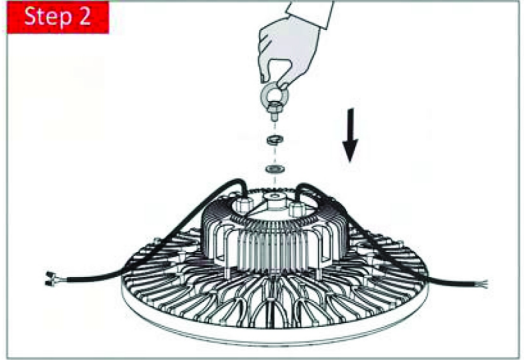

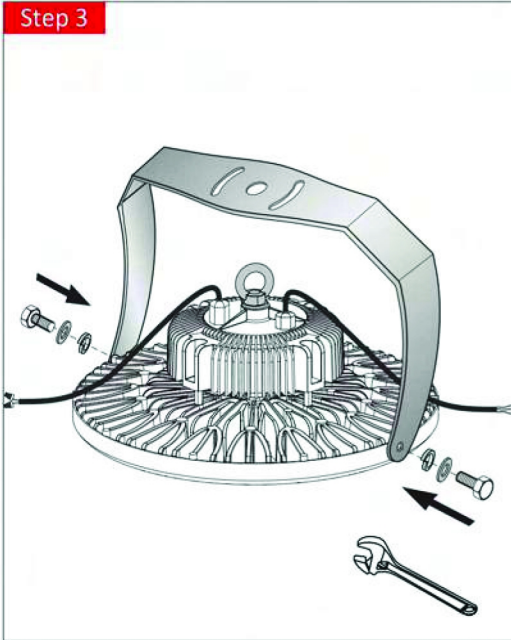

Step 3

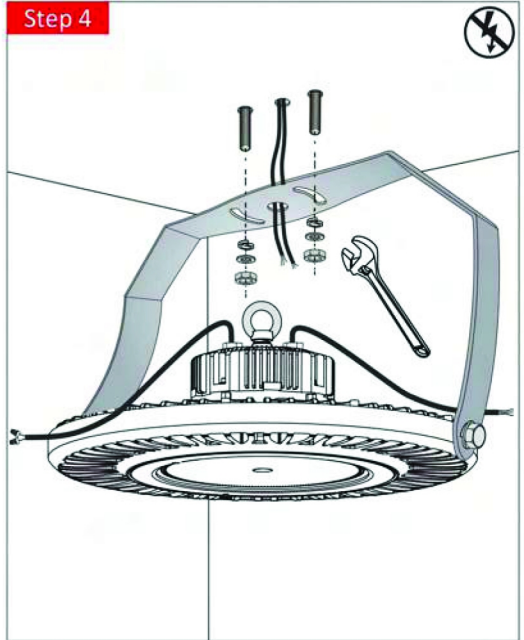

Step 4



Note:

	CE version:	ETL version:
①  1-10V dimming cable	+ Brown - Blue	+ Purple - Grey
②  100-277V AC cable	N Blue L Brown ⊙ Green	N White L Black ⊙ Green

Warning:

- ① Incorrect installation may result in power burned or a risk of a fire.
- ② If don't need dimming, protect the 1-10V output with the protection caps provided with the product.

Reflector Installation Manual (optional)

Step 1

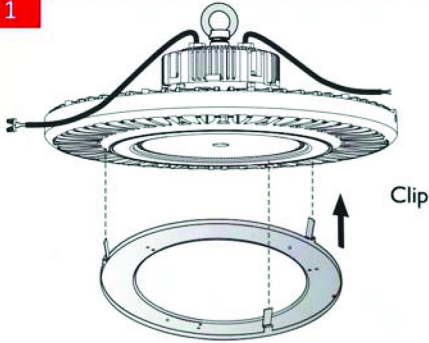

Step 2

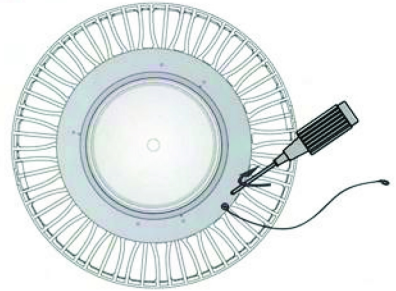

Step 3

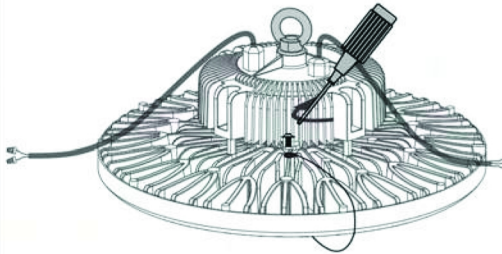

Step 4

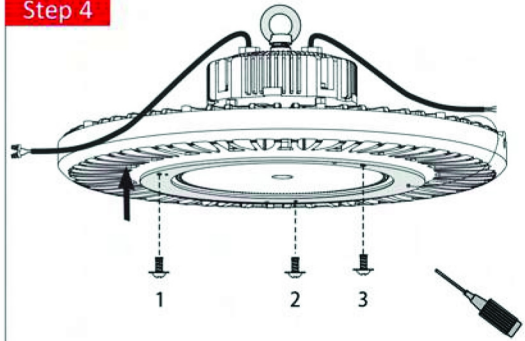

Step 5

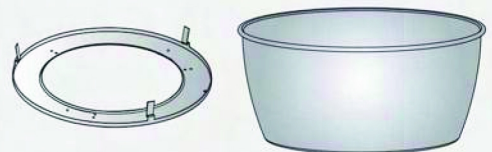
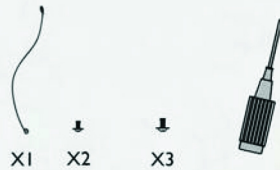

Suspension Chain Installation Manual

Step 5



Step 6 optional



X1



X1



X1



X1



X2

Wall Mounting Installation Manual

Step 5

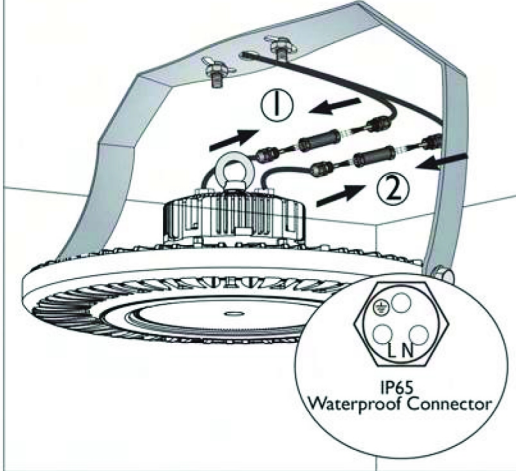

Step 6

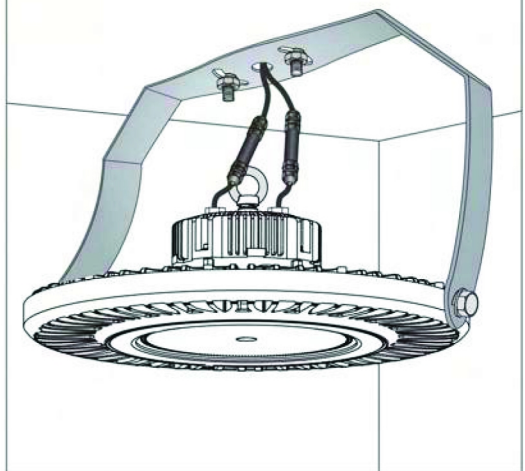

Step 7 optional

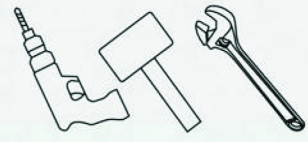
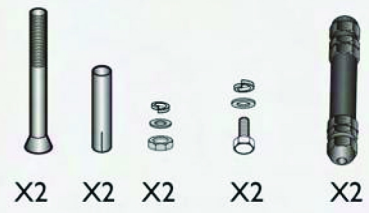
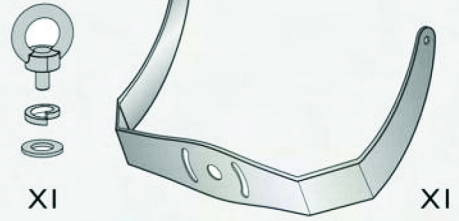
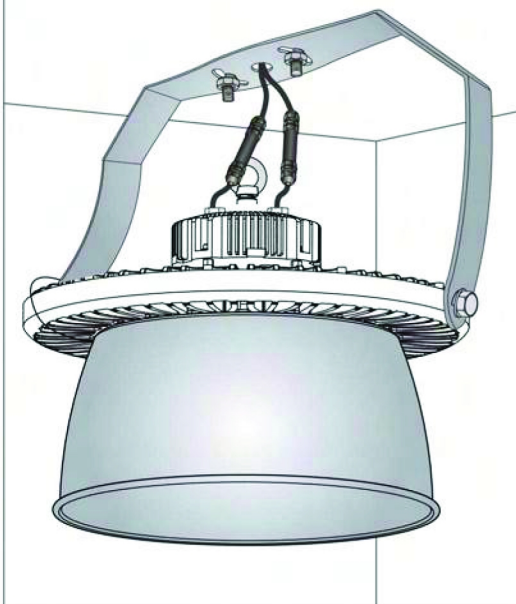

90° Reflector Installation Manual (optional)

Step 1

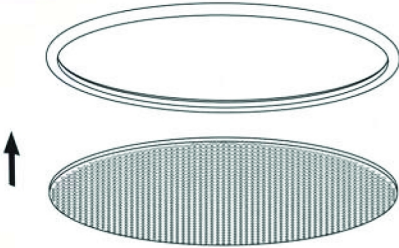

Step 2

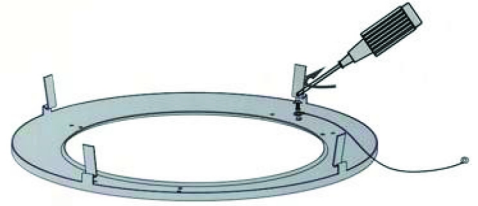

Step 3

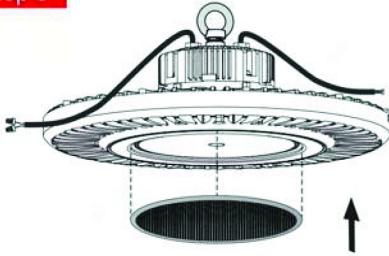

Step 4

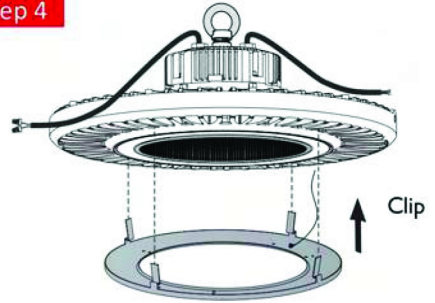

Step 5

