

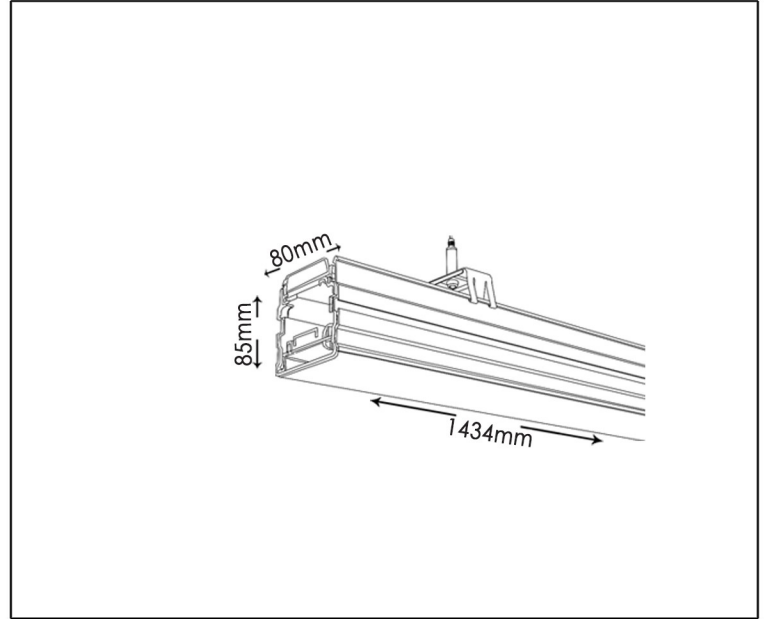

HIGHBAY LIGHTS

TECHNICAL DATA SHEET - FRINDER - 14185 - COMMERCIAL LIGHT SERIES

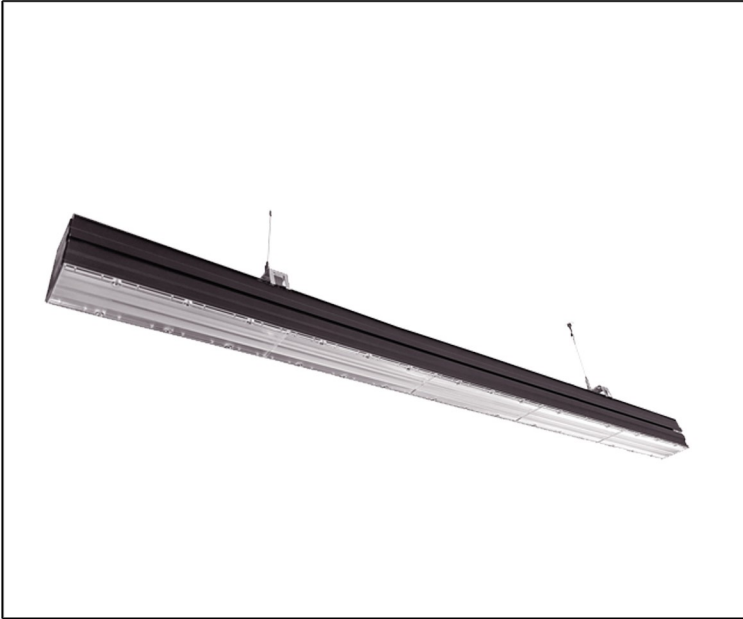

14185
 Samsung LED
 Rated Luminaire luminous flux: 7800lm
 Rated input power: 60W
 Luminaire efficiency: 130lm/w
 Input voltage: 100-240V

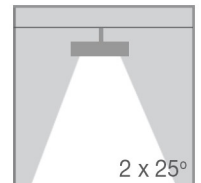
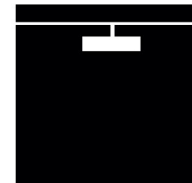
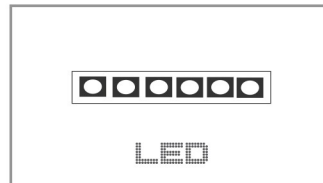

Product Description

We bring to you the innovating LED lighting products, Frinder - LED Linear Lightings, specially designed for supermarket, warehouse & office project

Technical Data

Product Data	LED Linear Light
Wattage	60W
Color Temperature	5700K
Rated Luminaire Luminous Flux	7800lm
IP	20
Beam Angle	2 x 25°
Frequency Range	50-60Hz
CRI	Ra>80
Power Factor	>0.9
Material	Aluminium Body
Finish	Black
Life Span	50,000Hrs
Warranty	5 Years
Applications	Commercial, Retail, Hospitality

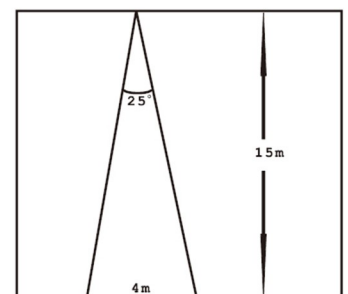
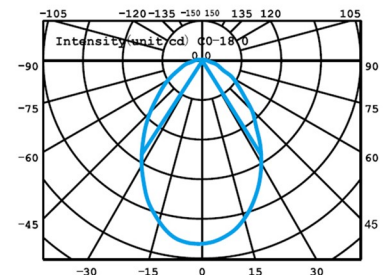

Options

Color Temperature	3000K - 6000K
Beam Angle	2x25°, 60°
Finish	Black, Dark Grey, Grey, Silver