

SYV[®]
design

WATERPROOF
BATTEN LIGHT

TECHNICAL DATA SHEET - STARK T8 - 11792 - BATTEN FITTING

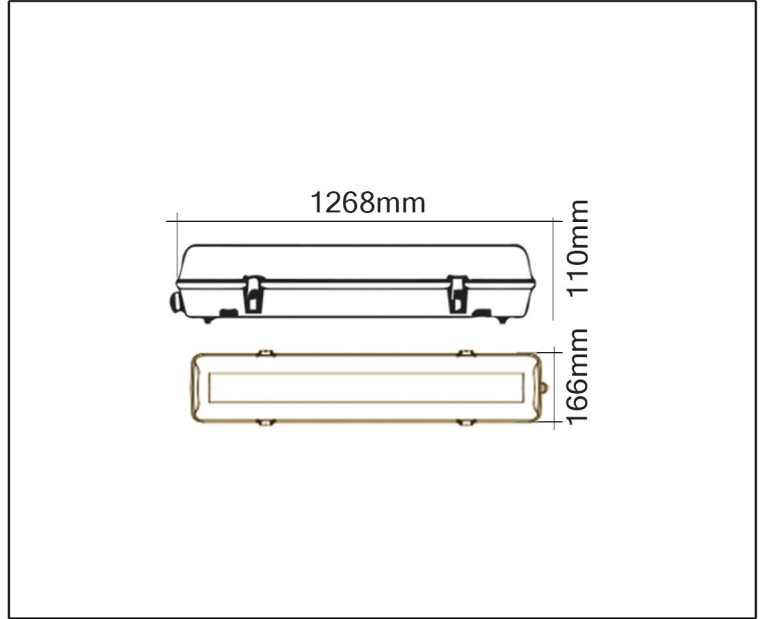

11792
T8 x 2
Rated input power: 2 x 36W
Input Voltage: 220-240V



Product Description

Stark fluorescent light with PC cover & ABS base provides functional lighting allowing ample brightness for any space. Stark makes it easier to plan your lighting needs for a comfortable environment.

Technical Data

Product Data	Batten Fitting
Wattage	2 x 36W
IP Rating	65
CRI	Ra>80
Power Factor	>0.9
Material	Waterproof fluorescent fixture + PC cover + ABS base
Finish	White
Life Span	30,000 hours
Warranty	3 Years
Applications	Residential, Commercial, Hospitality, etc.

